



EC-TYPE EXAMINATION CERTIFICATE (MODULE B)

Certificate No:
MEDB000005M
Revision No:
4

Application of: Directive 2014/90/EU of 23 July 2014 on marine equipment (MED), issued as "Forskrift om Skipsutstyr" by the Norwegian Maritime Authority. This Certificate is issued by DNV AS under the authority of the Government of Norway.

This is to certify:

That the A & B Class divisions fire integrity: A class divisions.

with type designation(s)

Steel Deck A30 with SeaRox FM 6030, SeaRox FM or FB 6040, SeaRox FB or FM 6050; stiffeners: SeaRox FM 6030, SeaRox FM 6040, SeaRox FB or FM 6050

Issued to

Rockwool A/S
Hedehusene, Denmark

is found to comply with the requirements in the following Regulations/Standards:

Regulation (EU) 2021/1158,

item No. MED/3.11a. SOLAS 74 as amended, Regulation II-2/3.2 & II-2/9, IMO 2010 FTP Code, IMO MSC/Circ.1120 and IMO MSC.1/Circ.1434, IMO MSC.1/Circ.1435.

Further details of the equipment and conditions for certification are given overleaf.

This Certificate is valid until **2025-07-27**.

Issued at **Høvik** on **2022-06-08**

DNV local station:
Sweden CMC

Approval Engineer:
Marcin Tobiasz



Notified Body
No.: **0575**



for **DNV AS**

Digitally Signed By:
Øyvind Hoff
Location: **DNV Høvik, Norway**
on behalf of

Sverre Olav Bergli
Head of Notified Body

A U.S. Coast Guard approval number will be assigned to the equipment when the production module has been completed and will appear on the production module certificate (module D, E or F), as allowed by the "Agreement between the United States of America and the EEA EFTA states on the mutual recognition of Certificates of Conformity for Marine Equipment" signed 17 October 2005, and amended by Decision No 1/2019 dated February 22nd, 2019.

The mark of conformity may only be affixed to the above type approved equipment and a Manufacturer's Declaration of Conformity issued when the production-surveillance module (D, E or F) of Annex B of the MED is fully complied with and controlled by a written inspection agreement with a Notified Body. The product liability rests with the manufacturer or his representative in accordance with Directive 2014/90/EU.

This certificate is valid for equipment, which is conform to the approved type. The manufacturer shall inform DNV AS of any changes to the approved equipment. This certificate remains valid unless suspended, withdrawn, recalled or cancelled.

Should the specified regulations or standards be amended during the validity of this certificate, the product is to be re-approved before being placed on board a vessel to which the amended regulations or standards apply.



LEGAL DISCLAIMER: Unless otherwise stated in the applicable contract with the holder of this document, or following from mandatory law, the liability of DNV AS, its parent companies and their subsidiaries as well as their officers, directors and employees ("DNV") arising from or in connection with the services rendered for the purpose of the issuance of this document or reliance thereon, whether in contract or in tort (including negligence), shall be limited to direct losses and under any circumstance be limited to 300,000 USD.





Job Id: 344.1-004879-5
Certificate No: MEDB000005M
Revision No: 4

Product description

"Steel Deck A30 with SeaRox FM 6030, SeaRox FM or FB 6040, SeaRox FB or FM 6050; stiffeners: SeaRox FM 6030, SeaRox FM 6040, SeaRox FB or FM 6050"

composed of steel deck to be insulated with one of the following variants:

1. SeaRox FB or FM 6040 (density 60 kg/m³, minimum thickness 35 mm) between the stiffeners and SeaRox FM 6030 (density 50 kg/m³, minimum thickness 30 mm) around the stiffener.
2. SeaRox FB or FM 6040 (density 60 kg/m³, minimum thickness 35 mm) between the stiffeners and SeaRox FM 6040 (density 60 kg/m³, minimum thickness 30 mm) around the stiffener.
3. SeaRox FB or FM 6040 (density 60 kg/m³, minimum thickness 35 mm) between the stiffeners and SeaRox FB or FM 6050 (density 70 kg/m³, minimum thickness 30 mm) around the stiffener
4. SeaRox FB or FM 6050 (density 70 kg/m³, minimum thickness 30 mm) between the stiffeners and SeaRox FM 6030 (density 50 kg/m³, minimum thickness 30mm) around the stiffener.
5. SeaRox FB or FM 6050 (density 70 kg/m³, minimum thickness 30 mm) between the stiffeners and SeaRox FM 6040 (density 60 kg/m³, minimum thickness 35mm) around the stiffener.
6. SeaRox FB or FM 6050 (density 70 kg/m³, minimum thickness 30 mm) between the stiffeners and SeaRox FB or FM 6050 (density 70 kg/m³, minimum thickness 30 mm) around the stiffener.
7. SeaRox FM 6030 (density 50 kg/m³, minimum thickness 30 mm) between the stiffeners and SeaRox FM 6030 (density 50 kg/m³, minimum thickness 30 mm) around the stiffener.
8. SeaRox FM 6040 (density 60 kg/m³, minimum thickness 35 mm) between the stiffeners and SeaRox FM 6040 (density 60 kg/m³, minimum thickness 30 mm) around the stiffener.

For all variants:

- The insulation is fixed to the bulkhead by means of standard Ø3 mm pins in combination with 30-38 diameter steel clips (spring washers).
- Distance between pins on the stiffeners is maximum 300 mm. Distance between pins on the bulkhead (between stiffeners) is maximum 300 mm.

For further details about pin-settings and design see drawings listed under Type Examination documentation below.

Application/Limitation

Approved for use as a horizontal fire retarding division of class A-30.

The insulation materials and adhesives used have to be approved according to the Marine Equipment Directive and bear the Mark of Conformity. This requirement may also be applicable for surface materials used, if required by relevant rules and regulations.

Each product is to be supplied with its manual for installation, use and maintenance.

Type Examination documentation

Test report No: PGA10662 dated 3 June 2015 from DBI, Hvidovre, Denmark.

Test report No: PGA10769A dated 4 November 2015 from DBI, Hvidovre, Denmark.

Assessment Report Nos.:

PHA10632f dated 30 January 2022 (valid until 30 January 2027) from DBI, Hvidovre, Denmark.

PHD10025A dated 5 July 2021 (valid until 5 July 2026) from DBI, Hvidovre, Denmark.

PHA10841A dated 1 December 2021 (valid until 1 December 2026) from DBI, Hvidovre, Denmark.

PHD10038A dated 27 October 2021 (valid until 27 October 2026) from DBI, Hvidovre, Denmark.

Drawing No. 200-1 dated 2 July 2015 from the manufacturer.

Drawing No. 200-2 dated 2 July 2015 from the manufacturer.

Drawing No. 200-3 dated 2 July 2015 from the manufacturer.

Drawing No. 200-4 dated 2 July 2015 from the manufacturer.

Drawing No. 200-5 dated 2 July 2015 from the manufacturer.

Drawing No. 210-1 Rev.2 dated 25 October 2021 from the manufacturer.

Drawing No. 210-2 Rev.2 dated 25 October 2021 from the manufacturer.

Drawing No. 210-3 Rev.2 dated 25 October 2021 from the manufacturer.

Drawing No. 210-4 Rev.2 dated 25 October 2021 from the manufacturer.

Drawing No. 310-1 dated 26 May 2016 from the manufacturer.



Job Id: **344.1-004879-5**
Certificate No: **MEDB000005M**
Revision No: **4**

Drawing No. 310-2 dated 26 May 2016 from the manufacturer.
Drawing No. 310-3 dated 26 May 2016 from the manufacturer.
Drawing No. 310-4 dated 26 May 2016 from the manufacturer.

Tests carried out

Tested according to IMO 2010 FTP Code part 3.

Marking of product

The product is to be marked with name and address of manufacturer, type designation, MED Mark of Conformity and USCG approval number if applicable (see first page).

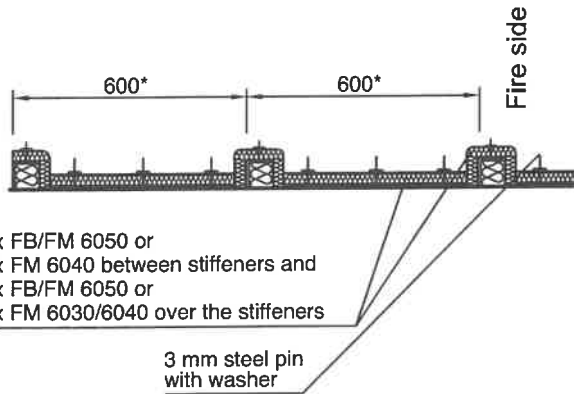
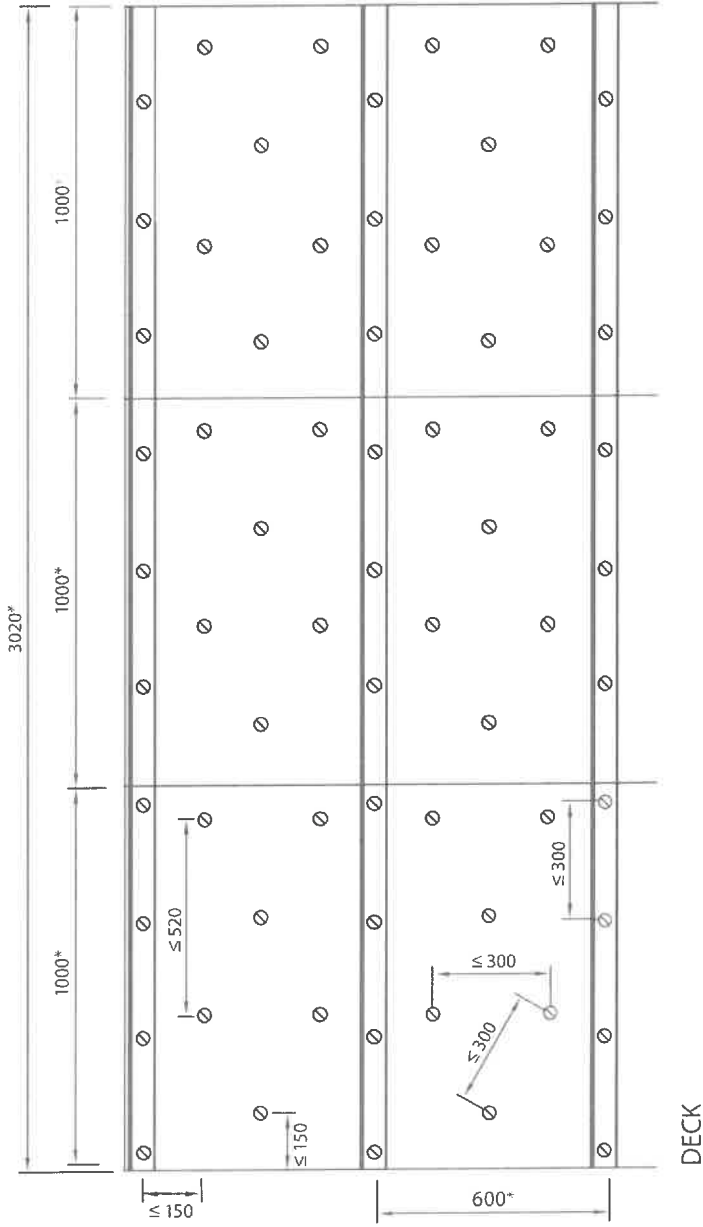

30 mm SeaRox FB/FM 6050 or
 35 mm SeaRox FM 6040 between stiffeners and
 30 mm SeaRox FB/FM 6050 or
 30 mm SeaRox FM 6030/6040 over the stiffeners

3 mm steel pin
 with washer

All measurements in mm

* Dimensions may vary depending on structural design and size of insulation material.



TECHNICAL INSULATION



Van Der

Subject: A-30 Steel Deck
 Plate: SeaRox FB/FM 6050 or SeaRox FM 6040/
 Stiffener: SeaRox FB/FM 6050 or SeaRox FM 6030/6040

Date: 2021/10/25

Designer: DG

Drawing No.210-1 / Rev 1

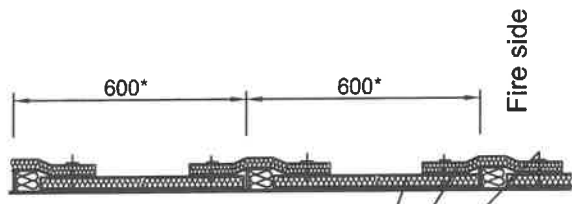
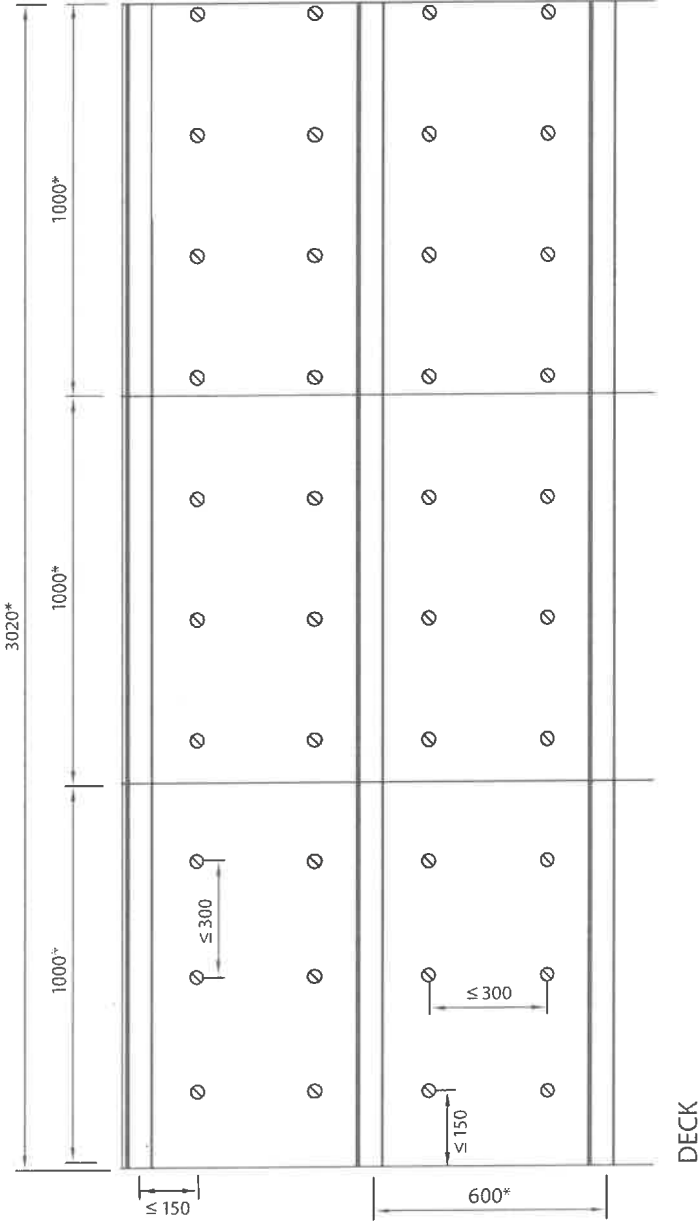

30 mm SeaRox FB/FM 6050 or
 35 mm SeaRox FM 6040 between stiffeners and
 30 mm SeaRox FB/FM 6050 or
 30 mm SeaRox FM 6030/6040 over the stiffeners

3 mm steel pin
 with washer

* Dimensions may vary depending on structural design and size of insulation material. All measurements in mm



Handwritten signature

Subject: A-30 Steel Deck
 Plate: SeaRox FB/FM 6050 or SeaRox FM 6040/
 Stiffener: SeaRox FB/FM 6050 or SeaRox FM 6030/6040

Date: 2021/10/25 Designer: DG Drawing No.210-2 / Rev 1



TECHNICAL INSULATION

TOP VIEW

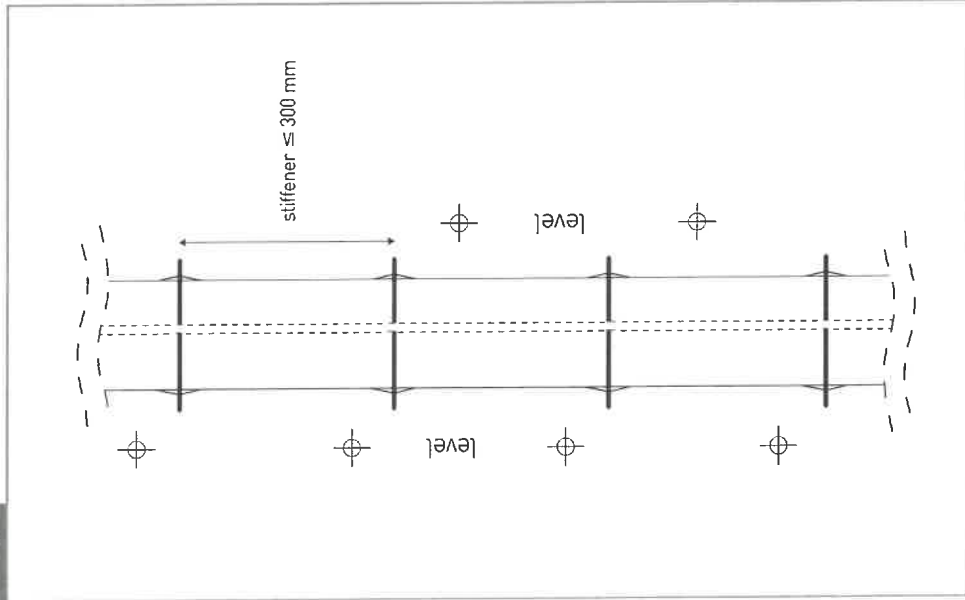

SECTION A

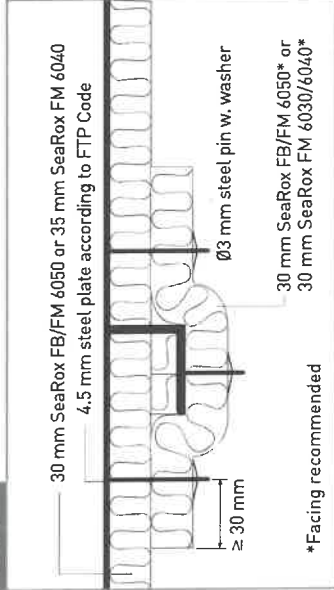

SECTION B

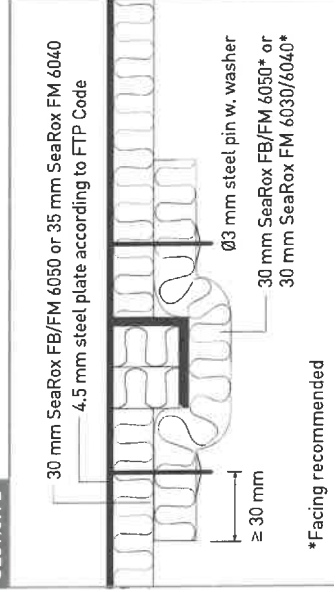

SECTION C

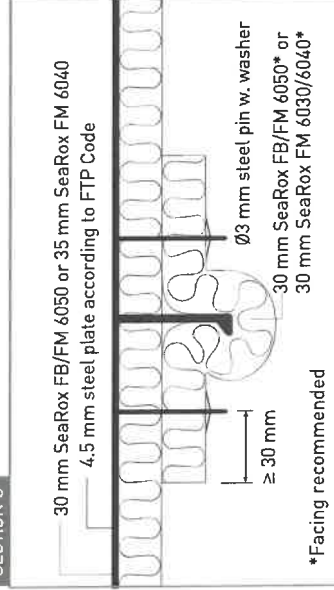

SECTION D

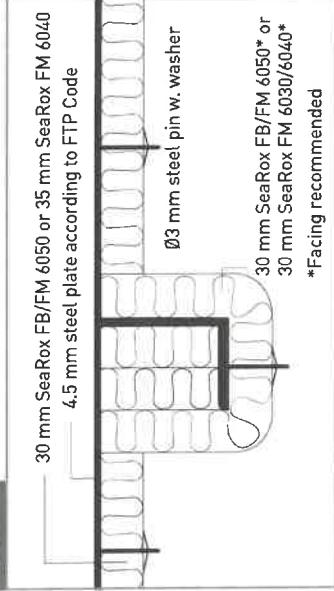

SECTION E

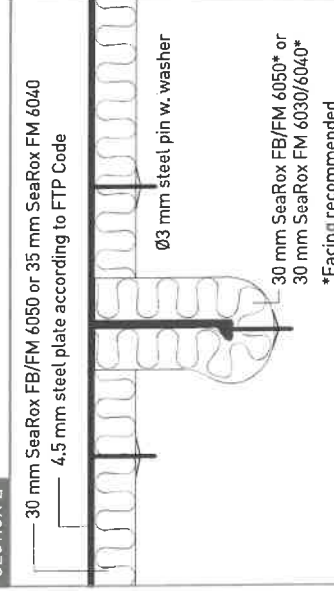

SECTION F

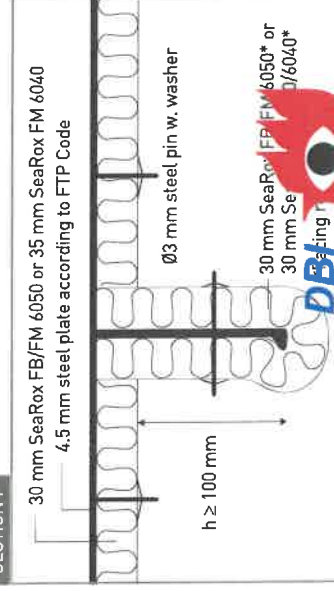

Subject: A-30 Steel Deck
Plate: SeaRox FB/FM 6050 or SeaRox FM 6040/
Stiffener: SeaRox FB/FM 6050 or SeaRox FM 6030/6040

TECHNICAL INSULATION

Date: 2021/10/25

Designer: DG

Drawing No.210-3 / Rev 1

TOP VIEW

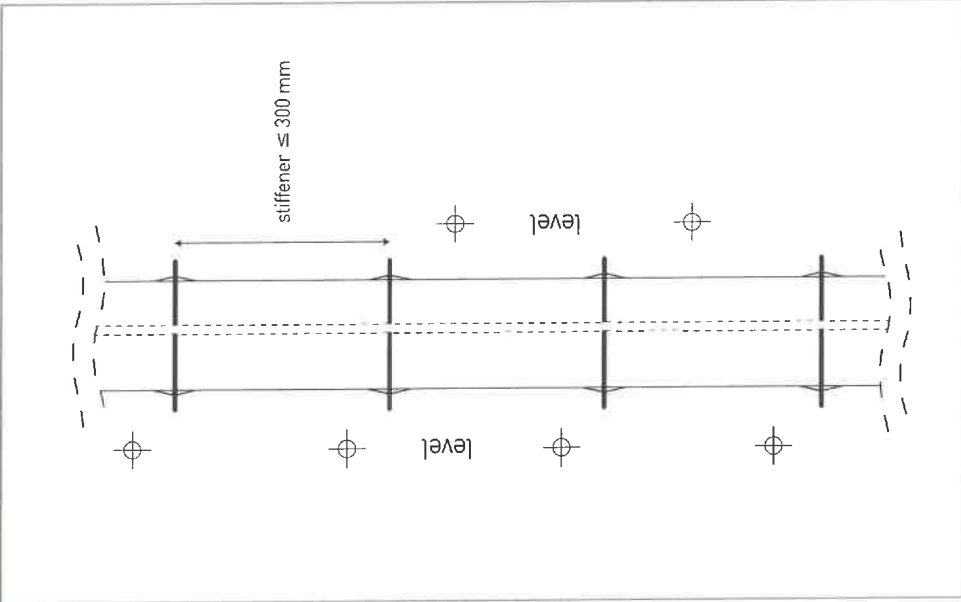

SECTION G

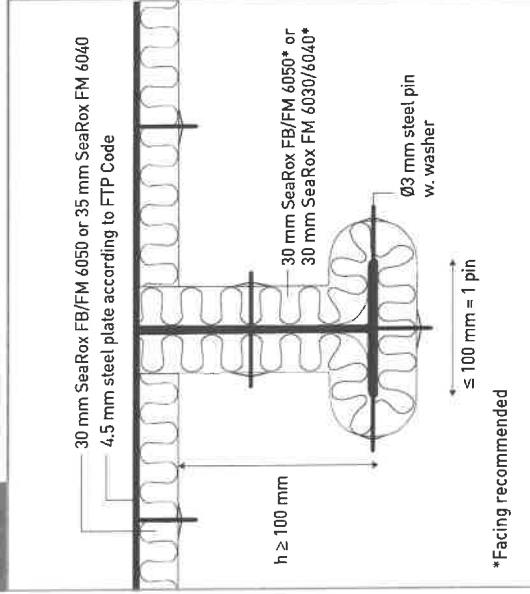

SECTION H

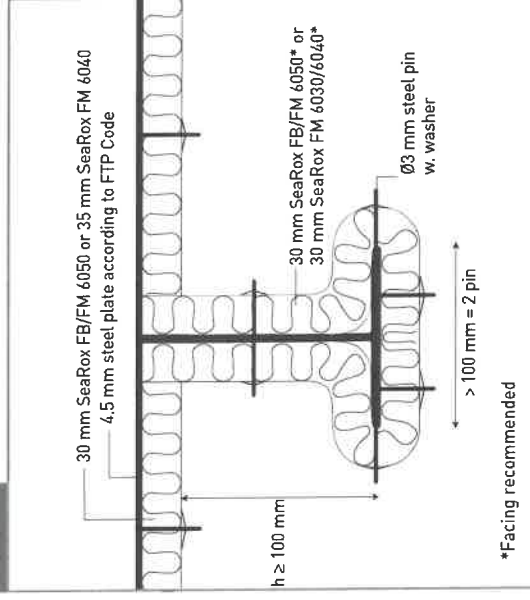

Handwritten signature

Subject: A-30 Steel Deck

Plate: SeaRox FB/FM 6050 or SeaRox FM 6040/
Stiffener: SeaRox FB/FM 6050 or SeaRox FM 6030/6040

Date: 2021/10/25

Designer: DG

Drawing No.210-4 / Rev 1



TECHNICAL INSULATION